



















Acessórios

-  Paraf. Ø4,0x45 mm 52
Montagem estrutura
-  Paraf. Ø3,5x40 mm 10
Montagem estrutura
-  Par. Ø3,5x25 mm 12
puxadores
-  Par. Ø3,5x14 mm 110
P/cantoneiras, cabideiro, corrediças, Dobradiça e calço
-  Par. Ø3,5x12 mm 64
-  Cavilha Ø6x30 mm 24
Montagem estrutura
Gavetas e rodapés
-  Ø26mm 24
Dobradiça CURVA
-  Calço 5 (Baixo) 24
Portas laterais
-  Puxador 6
-  Suporte cabideiro 8
-  Corrediça 4
(paraf. Ø3,5x14mm) pares
-  Batente de porta 6
-  Perfil H mm 3
-  Cantoneira 16
P/ gavetas
moldura superior
-  Distanciador 16
Gavetas
-  Pregos 10 x 10 180
Fundos
-  Cola branca(sache) 2
P/cavilhas
-  Cabideiro 4
Metal - 755mm

Montagem da estrutura

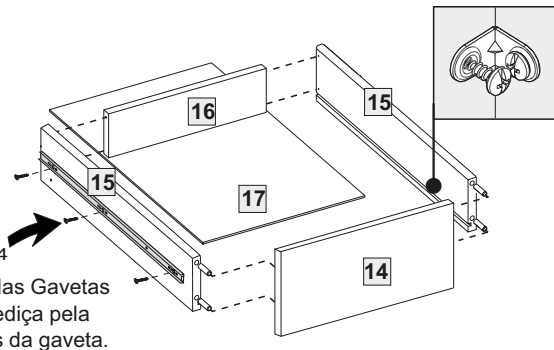
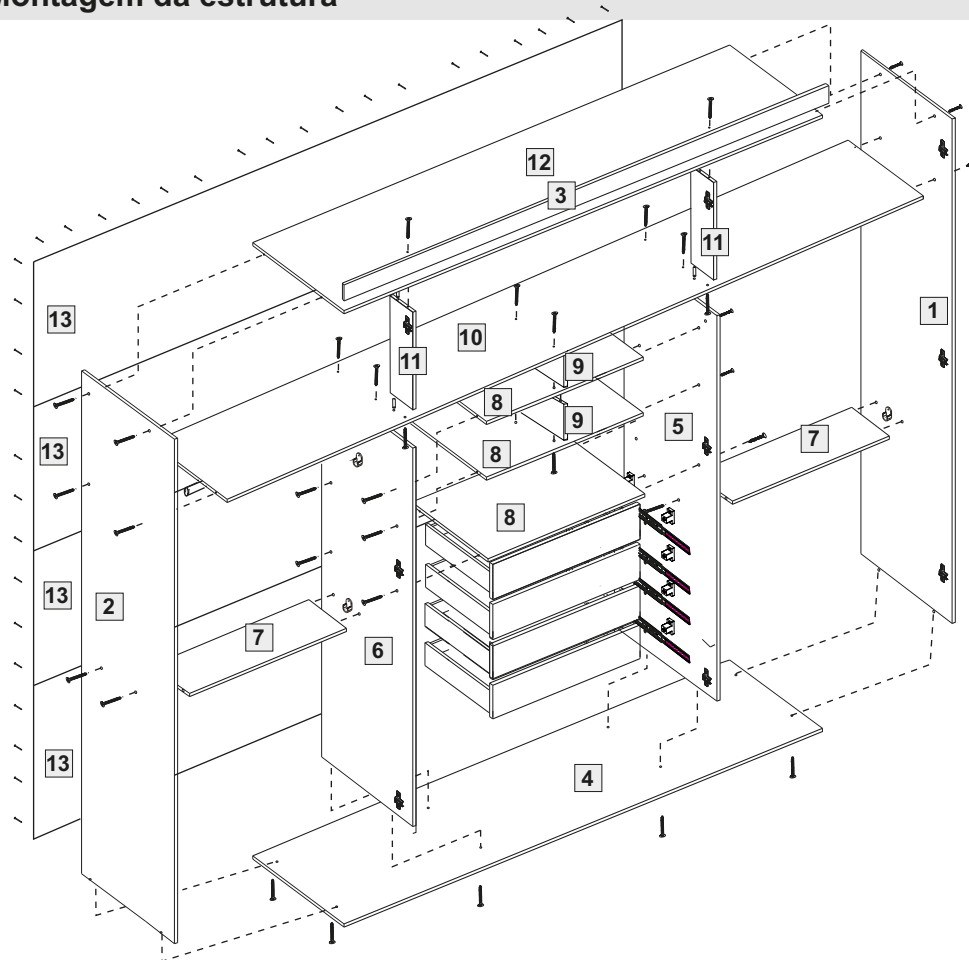

Montagem das Gavetas
Alinhar corrediça pela
parte de trás da gaveta.

ROUPEIRO MUNIQUE / CANCÚN 6 PORTAS

Larg.:2350mm Alt.: 2300mm Prof.:540mm



Item	Componente	QT.	ALT. X LARG.
01	Lateral Direita	01	520 x 2.240mm
02	Lateral esquerda	01	520 x 2.240mm
03	Moldura	01	85 x 2.353mm
04	Base	01	540 x 2.360mm
05	Divisão Vertical Direita	01	520 x 1.780mm
06	Divisão Vertical esquerda	01	520 x 1.780mm
07	Prateleira Cabideiros	02	260 x 764mm
08	Divisão Media Colmeia/Gavetas	03	520 x 764mm
09	Divisão Pequena Colmeia	02	310 x 445mm
10	Divisão do Maleiro	01	520 x 2.320mm
11	Montante do Maleiro	02	90 x 350mm
12	Chapéu	01	520 x 2.320mm
13	Fundo	04	542 x 2.348mm
14	Frente de Gaveta	04	150 x 710mm
15	Lateral de Gaveta	08	95 x 350mm
16	Traseira de Gaveta	04	80 x 665mm
17	Fundo de Gaveta	04	350 x 687mm
18	Pezinhos	08	43 x 200mm

Conservação e Limpeza

Para a limpeza basta utilizar pano macio ligeiramente úmido.

Não use álcool ou abrasivos que poderão danificar a camada de verniz.

